



## Main

Range of product	Harmony K
Product or component type	Complete cam switch
Component name	K1
[I <sub>th</sub> ] conventional free air thermal current	12 A
Product mounting	Front mounting
Fixing mode	Ø 22 mm hole
Cam switch head type	With front plate 45 x 45 mm
Type of operator	Black handle, length = 35 mm
Rotary handle padlocking	Without
Presentation of legend	With metallic legend, 2 - 0 - 1 black marking
Cam switch function	Changeover switch
Return	Without
Off position	With Off position
Poles description	3P
Switching positions	Left: 0° - 315° Right: 0° - 45°
IP degree of protection	IP65 conforming to IEC 529 IP65 conforming to NF C 20-010

## Complementary

Switching angle	45 °
[U <sub>i</sub> ] rated insulation voltage	690 V (pollution degree 3) conforming to IEC 60947-1
[I <sub>the</sub> ] conventional enclosed thermal current	10 A
Rated operational power in W	10500 W AC-21, 500...660 V 3 phases conforming to IEC 947-3 1100 W AC-3, 230 V 3 phases conforming to IEC 947-3 1500 W AC-23A, 230 V 3 phases conforming to IEC 947-3 1500 W AC-3, 400 V 1 phase conforming to IEC 947-3 1500 W AC-3, 400 V 3 phases conforming to IEC 947-3 1500 W AC-3, 500 V 3 phases conforming to IEC 947-3 1500 W AC-3, 690 V 3 phases conforming to IEC 947-3 2200 W AC-23A, 400 V 3 phases conforming to IEC 947-3 2200 W AC-23A, 500 V 3 phases conforming to IEC 947-3 2200 W AC-23A, 690 V 3 phases conforming to IEC 947-3 4800 W AC-21, 230 V 3 phases conforming to IEC 947-3 600 W AC-3, 230 V 1 phase conforming to IEC 947-3 8300 W AC-21, 400 V 3 phases conforming to IEC 947-3
[I <sub>e</sub> ] rated operational current AC	1.8 A at 690 V AC-3 3 phases conforming to IEC 947-3 2.8 A at 500 V AC-3 3 phases conforming to IEC 947-3 2.8 A at 690 V AC-23A 3 phases conforming to IEC 947-3 3.3 A at 400 V AC-3 3 phases conforming to IEC 947-3 3.8 A at 500 V AC-23A 3 phases conforming to IEC 947-3 4.6 A at 230 V AC-3 3 phases conforming to IEC 947-3 4.8 A at 400 V AC-23A 3 phases conforming to IEC 947-3 5.6 A at 230 V AC-23A 3 phases conforming to IEC 947-3 1 A at 500 V AC-15 conforming to IEC 947-5-1 2 A at 400 V AC-15 conforming to IEC 947-5-1 3 A at 230 V AC-15 conforming to IEC 947-5-1
Electrical durability	1000000 Cycles AC-15 1000000 Cycles AC-21 500000 Cycles AC-23 500000 Cycles AC-3
Maximum operating rate	2.5 Cyc/Mn AC-21 2.5 Cyc/Mn AC-23 2.5 Cyc/Mn AC-3 8.333 Cyc/Mn AC-15
Short-circuit current	10000 A
Short-circuit protection	16 A cartridge fuse, type gG
[U <sub>imp</sub> ] rated impulse withstand voltage	4 KV in isolating function 6 KV conforming to IEC 947-1
Contact operation	Slow-break
Positive opening	With
Electrical connection	Captive screw clamp terminals flexible, clamping capacity: 2 x 1.5 mm <sup>2</sup> Captive screw clamp terminals solid, clamping capacity: 1 x 2.5 mm <sup>2</sup>

Mechanical durability	1000000 Cycles
CAD overall width	45 Mm
CAD overall height	50 Mm
CAD overall depth	69 Mm
Product weight	0.19 Kg

## Environment

Standards	EN 60947-3 for power circuit EN 60947-5-1 for control circuit IEC 60947-3 for power circuit IEC 60947-5-1 for control circuit CENELEC EN 50013
Product certifications	CSA 240 V 3 hp 3 phases 2 pole(s) UL 240 V 0.33 hp 1 phase 2 pole(s) CSA 240 V 1 hp 1 phase UL 240 V 1 hp 3 phases
Protective treatment	TC
Ambient air temperature for operation	-25...55 °C
Ambient air temperature for storage	-40...70 °C
Shock resistance	30 gn conforming to IEC 68-2-27
Vibration resistance	5 gn conforming to IEC 68-2-6 (f = 10...150 Hz)
Electrical shock protection class	Class II conforming to IEC 536 Class II conforming to NF C 20-030

## Packing Units

Unit Type of Package 1	PCE
Number of Units in Package 1	1
Package 1 Height	6.500 Cm
Package 1 Width	6.500 Cm
Package 1 Length	16.500 Cm
Package 1 Weight	202.000 G
Unit Type of Package 2	S01
Number of Units in Package 2	8
Package 2 Height	15.000 Cm
Package 2 Width	15.000 Cm
Package 2 Length	40.000 Cm
Package 2 Weight	1.771 Kg

## Offer Sustainability

Sustainable offer status	Green Premium product
REACH Regulation	<a href="#">REACH Declaration</a>
REACH free of SVHC	Yes
EU RoHS Directive	Pro-active compliance (Product out of EU RoHS legal scope) <a href="#">EU RoHS Declaration</a>
Toxic heavy metal free	Yes
Mercury free	Yes
RoHS exemption information	<a href="#">Yes</a>
China RoHS Regulation	<a href="#">China RoHS Declaration</a>
Environmental Disclosure	<a href="#">Product Environmental Profile</a>
WEEE	The product must be disposed on European Union markets following specific waste collection and never end up in rubbish bins

## Contractual warranty

Warranty	18 months
----------	-----------

---

Operating Head and Body with Plastic Base

---

Front Mounting by  $\varnothing 22$  mm/0.87 in. Hole

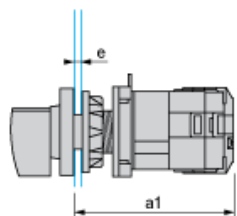

a1 90.5 mm/3.53 in.

e support panel thickness 1 mm to 6 mm./0.039 in. to 0.24 in.

Link Positions (Factory Mounted)

Diagram for 1 to 4-pole Switches

Select the number of poles according to the product characteristics.

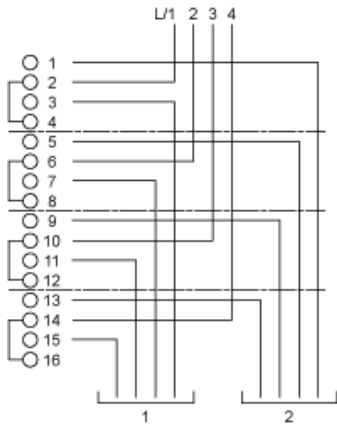

Marking

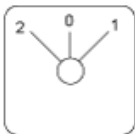

Angular Position of Switch

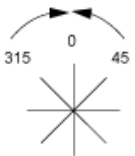

Switching Program

Diagram for 1 to 4-pole Switches

Select the number of poles according to the product characteristics.

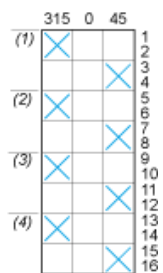



- (1) 1-pole
- (2) 2-pole
- (3) 3-pole
- (4) 4-pole

## Convention Used for Switching Program Representation

---

 Contact closed

 Contact closed in 2 positions and maintained between the 2 positions

 Sealed assembly for auto-maintain control

 Overlapping contacts

 Spring return position: for a switching angle of 90°, spring return is over 30° after the last position (for a maximum of 3 simultaneous contacts).

Example:

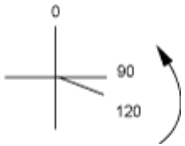

Product Life Status : **Commercialised**