



Main

Range	TeSys Deca TeSys Deca
Product name	TeSys GV2 TeSys Deca
Product or component type	Motor circuit breaker
Device short name	GV2P
Device application	Motor protection
Trip unit technology	Thermal-magnetic

Complementary

Poles description	3P
Network type	AC
Utilisation category	AC-3 conforming to IEC 60947-4-1 Category A conforming to IEC 60947-2
Network frequency	50/60 Hz conforming to IEC 60947-4-1
Motor power kW	5.5 kW at 400/415 V AC 50/60 Hz 7.5 kW at 500 V AC 50/60 Hz 9 kW at 690 V AC 50/60 Hz 11 kW at 690 V AC 50/60 Hz
Breaking capacity	100 KA Icu at 230/240 V AC 50/60 Hz conforming to IEC 60947-2 100 KA Icu at 400/415 V AC 50/60 Hz conforming to IEC 60947-2 50 KA Icu at 440 V AC 50/60 Hz conforming to IEC 60947-2 6 KA Icu at 690 V AC 50/60 Hz conforming to IEC 60947-2 42 KA Icu at 500 V AC 50/60 Hz conforming to IEC 60947-2
[Ics] rated service short-circuit breaking capacity	100 % at 690 V AC 50/60 Hz conforming to IEC 60947-2 100 % at 230/240 V AC 50/60 Hz conforming to IEC 60947-2 100 % at 400/415 V AC 50/60 Hz conforming to IEC 60947-2 75 % at 500 V AC 50/60 Hz conforming to IEC 60947-2 75 % at 440 V AC 50/60 Hz conforming to IEC 60947-2
Control type	Rotary handle
[In] rated current	14 A
Magnetic tripping current	170 A
[Ith] conventional free air thermal current	14 A conforming to IEC 60947-4-1
[Ue] rated operational voltage	690 V AC 50/60 Hz conforming to IEC 60947-2
[Uimp] rated impulse withstand voltage	6 KV conforming to IEC 60947-2
Phase failure sensitivity	Yes conforming to IEC 60947-4-1
Suitability for isolation	Yes conforming to IEC 60947-1 § 7-1-6
Power dissipation per pole	2.5 W
Mechanical durability	100000 Cycles

Electrical durability	100000 Cycles for AC-3 at 415 V
Rated duty	Continuous conforming to IEC 60947-4-1
Width	45 Mm
Height	89 Mm
Depth	97 Mm





Environment

Standards	EN/IEC 60947-2 EN/IEC 60947-4-1
Product certifications	CCC UL CSA EAC ATEX BV LROS (Lloyds register of shipping) UKCA DNV-GL RINA
IP degree of protection	IP20 conforming to IEC 60529
Climatic withstand	Conforming to IACS E10
Ambient air temperature for storage	-40...80 °C
Fire resistance	960 °C conforming to IEC 60695-2-11
Ambient air temperature for operation	-20...60 °C
Operating altitude	2000 m

Packing Units

Unit Type of Package 1	PCE
Number of Units in Package 1	1
Package 1 Height	5 Cm
Package 1 Width	9.5 Cm
Package 1 Length	10 Cm
Package 1 Weight	335 G
Unit Type of Package 2	S02
Number of Units in Package 2	20
Package 2 Height	15 Cm
Package 2 Width	30 Cm
Package 2 Length	40 Cm
Package 2 Weight	6.944 Kg
Unit Type of Package 3	P06
Number of Units in Package 3	320
Package 3 Height	75 Cm
Package 3 Width	80 Cm
Package 3 Length	60 Cm
Package 3 Weight	119.104 Kg

Offer Sustainability

Sustainable offer status	Green Premium product
REACH Regulation	 REACH Declaration
EU RoHS Directive	Compliant  EU RoHS Declaration
Mercury free	Yes
RoHS exemption information	 Yes
China RoHS Regulation	 China RoHS Declaration
Environmental Disclosure	 Product Environmental Profile
Circularity Profile	 End Of Life Information
WEEE	The product must be disposed on European Union markets following specific waste collection and never end up in rubbish bins

Contractual warranty

Warranty	18 months
----------	-----------

Thermal-Magnetic Tripping Curves for GV2ME and GV2P

Average Operating Times at 20 °C Related to Multiples of the Setting Current

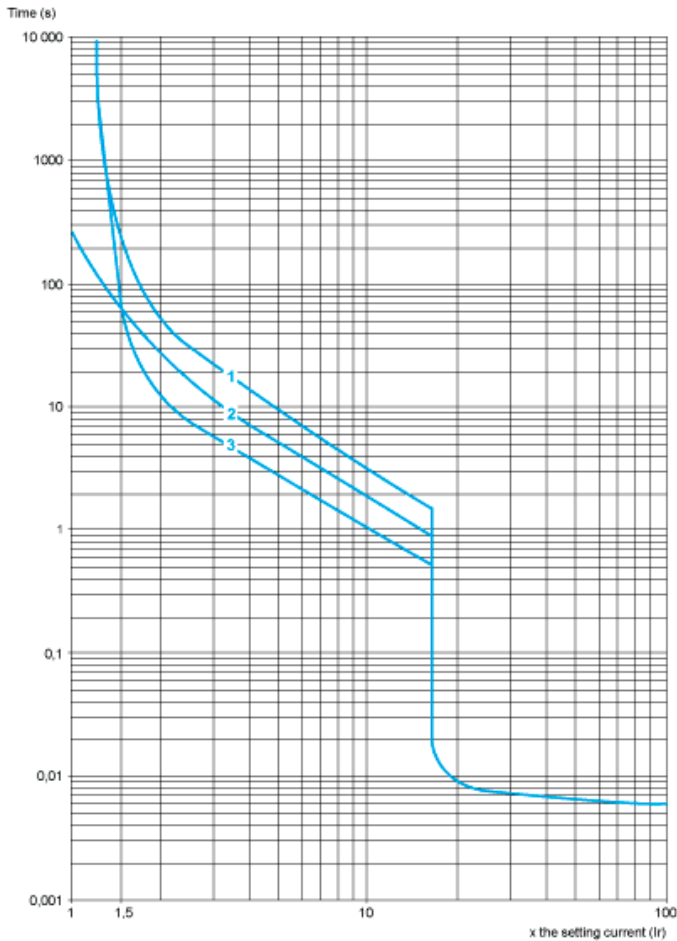

- 1 3 poles from cold state
- 2 2 poles from cold state
- 3 3 poles from hot state

Current Limitation on Short-Circuit for GV2ME and GV2P (3-Phase 400/415 V))

Dynamic Stress

$I_{peak} = f(\text{prospective } I_{sc}) \text{ at } 1.05 U_e = 435 \text{ V}$

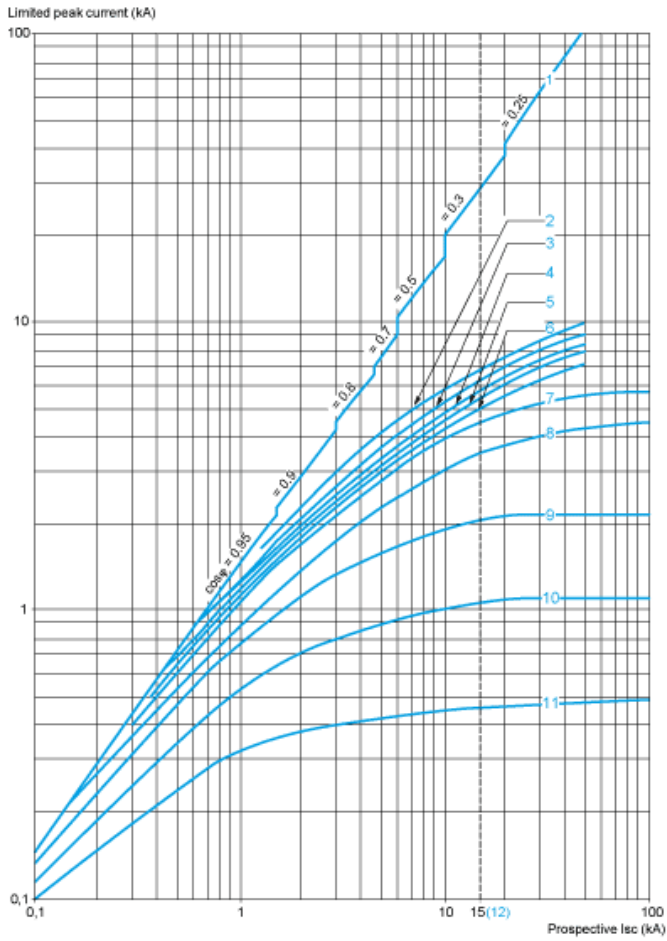

- 1 Maximum peak current
- 2 24-32 A
- 3 20-25 A
- 4 17-23 A
- 5 13-18 A
- 6 9-14 A
- 7 6-10 A
- 8 4-6.3 A
- 9 2.5-4 A
- 10 1.6-2.5 A
- 11 1-1.6 A
- 12 Limit of rated ultimate breaking capacity on short-circuit of GV2ME (14, 18, 23, and 25 A ratings).

Thermal Limit on Short-Circuit for GV2P

Thermal Limit in kA^2s in the Magnetic Operating Zone

Sum of $I^2dt = f$ (prospective I_{sc}) at $1.05 U_e = 435 V$

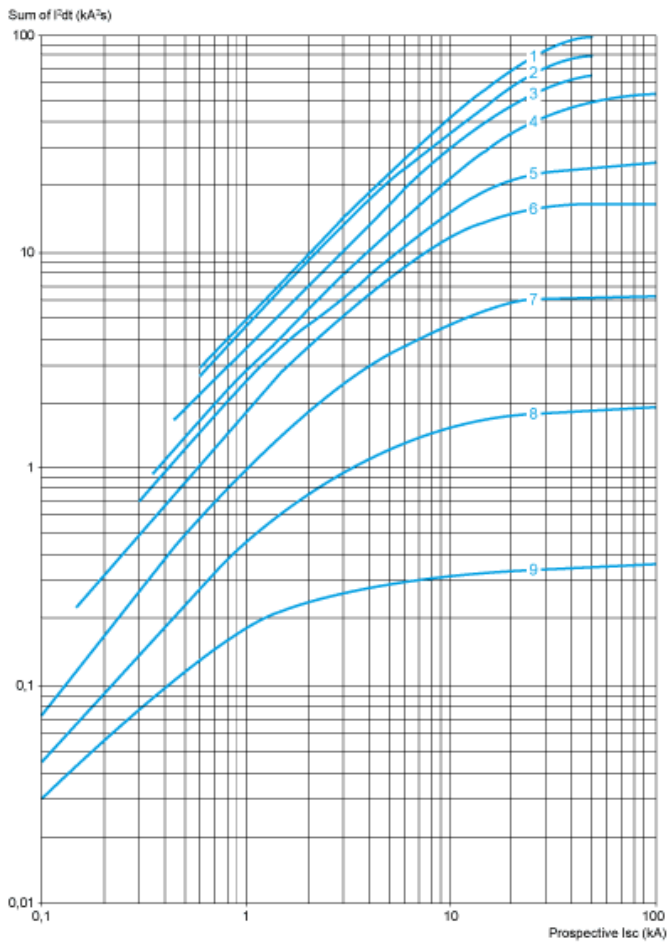

- 1 24-32 A
- 2 20-25 A
- 3 17-23 A
- 4 13-18 A
- 5 9-14 A
- 6 6-10 A
- 7 4-6.3 A
- 8 2.5-4 A
- 9 1.6-2.5 A
- 10 1-1.6 A

GV2P

On rail AM1 DE200, ED200 (35 x 15)

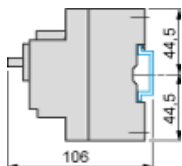

Panel mounted

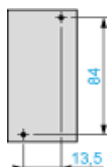

On pre-slotted plate AM1 PA

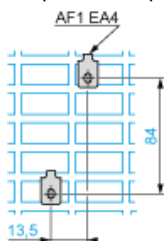

Adapter plate GK2AF01

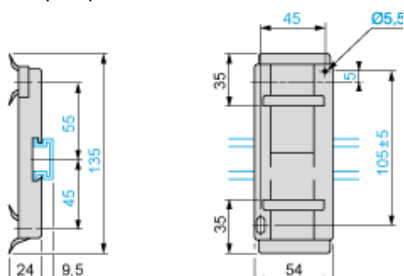

Combination GV2P + TeSys d contactor

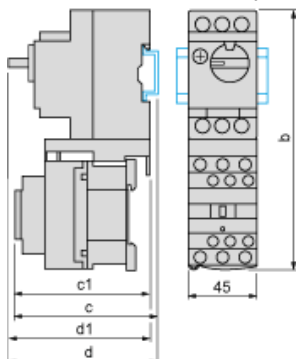

GV2P +	LC1D09...D18	LC1D25 and D32
b	176.4	186.8
c1	100.1	106.4
c	105.6	111.9
d1	95	95
d	100.5	100.5

Mounting

Mounting of External Operator GV2APN01, GV2APN02 or GV2APN04 for Motor Circuit Breakers GV2P

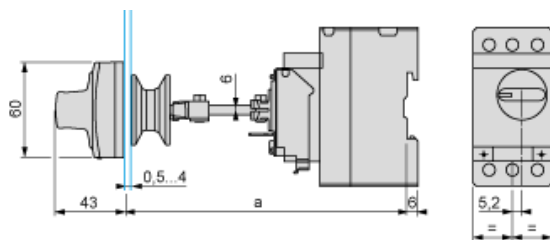

Door cut-out

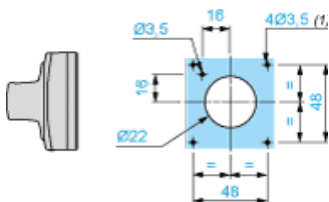

(1) For IP65 only.

Mounting of External Operator GVAPH02 for Motor Circuit Breakers GV2P

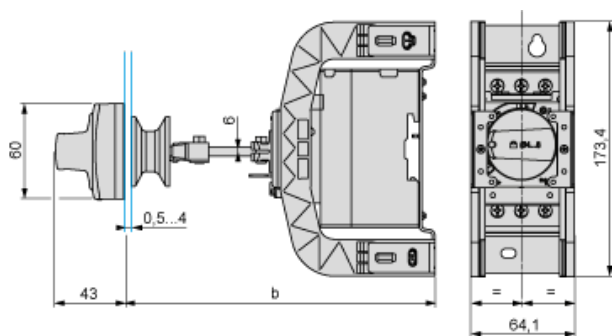

	a		b	
	Minimum	Maximum	Minimum	Maximum
GV2APN..	140	250	–	–
GV2APN.. + GVAPH02	–	–	151	250
GV2APN.. + GVAPK11	250	434	–	–
GV2APN.. + GVAPH02 + GVAPK11	–	–	250	445

Door cut-out

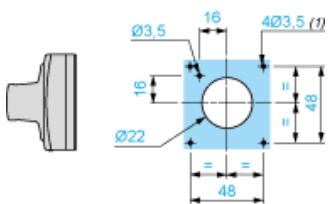

(1) For IP65 only.

GV2P••

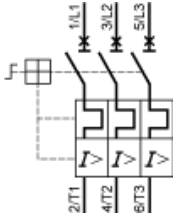

Product Life Status : **Commercialised**